



Alfa Romeo 4C Immersion

Italian Style

Rear Details

- Rear decklid
 - Provides access to the trunk as well as a full, unobstructed view of the engine compartment
 - Propped up by a simple prop rod to keep weight down. Don't lean on the decklid, it will bend
 - Trunk is small for the average car but perfect for this pinnacle of performance
- Rear LED illuminated light clusters – illuminate brightly and add visual flair to an already alluring rear end
- Available Rear Parking Sensors – four sensors integrated into the rear fascia help detect the presence of obstacles; the in-cluster display illuminates and the system beeps to indicate object proximity and general location

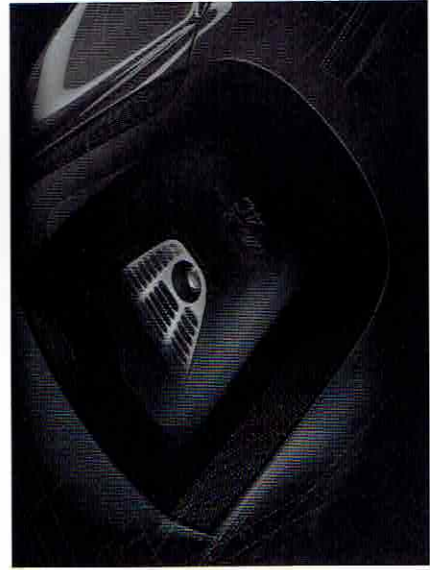

ENGINE
BAY

APPROPRIATELY
SIZED TRUNK

Alfa Romeo 4C Immersion Italian Style

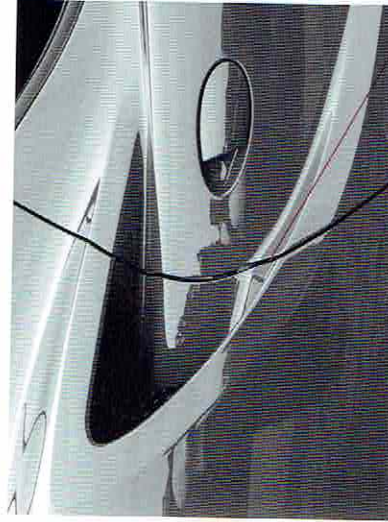

PERFECTLY MATCHED GAPS



CONSISTENT GAP

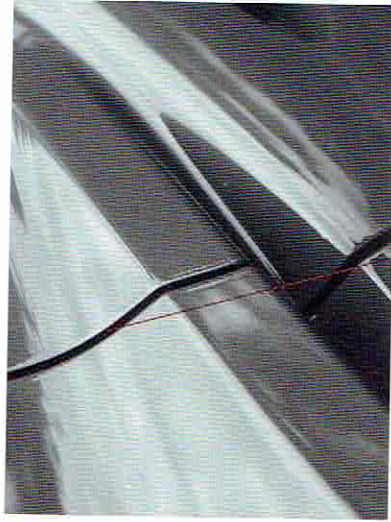

obstacles;

ENGINE
BAY

APPROPRIATELY
SIZED TRUNK

Hand-Assembled Craftsmanship

- Body panel gaps
 - Consistent along the entire door edge and from side to side
 - Vehicle is hand-assembled at Maserati's plant in Modena, Italy, alongside a line that assembles production Maserati vehicles

4C PURE PASSION

Alfa Romeo 4C Immersion Italian Style

Driver-Centric Cockpit

- Instruments and controls angled toward the driver
- Inviting interior – finely crafted but devoid of unnecessary frills
- Exposed carbon fiber – draws the eye and contributes to the race-ready look
- Dashboard shell – available in thermoformed or leather and featuring accent stitching
- Aluminum pedals – mounted to the floor for a racier look and a more natural feel
- Flat-bottom steering wheel – less intrusive than a conventional wheel; tilts and telescopes

Praise for Passion

"Of particular note inside is the central tub's exposed carbon fiber. Unlike most cars, which want to show off their CF intensity by wrapping either the mirror or the front splitter in carbon, in the 4C you're seated in the actual business. It's captivating, and frankly, the first time I've liked exposed carbon on a car's interior."

– Motor Trend



DASHBOARD SHELL

FLAT-BOTTOM STEERING WHEEL

LEATHER DOOR PULL

EXPOSED CARBON FIBER

Alfa Romeo 4C Immersion Italian Style

Race-Ready Bucket Seats

- Reinforced composite structure – provides incredible strength while keeping the seats thin and lightweight
- Pronounced bolstering – hugs occupants and keeps them firmly in place
- Cloth, leather or leather/microfiber trim – to suit any driver's taste

ULTRA-WIDE BOLSTERS

COMPOSITE STRUCTURE

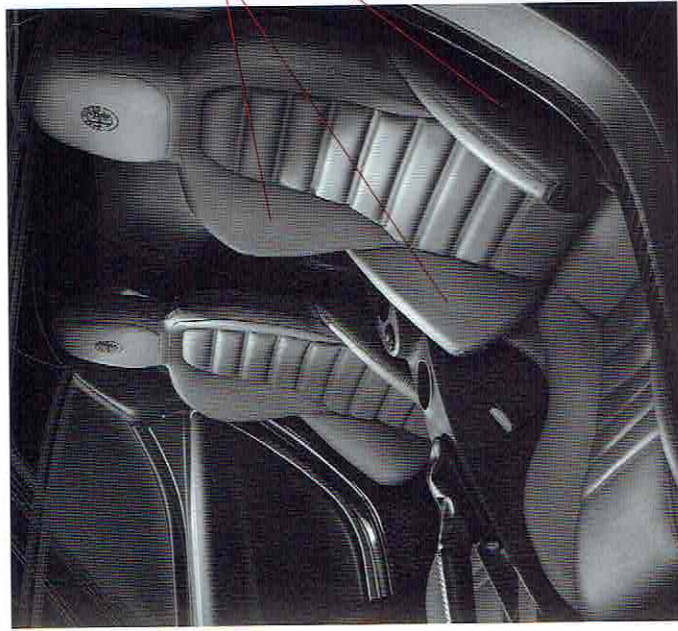

NOTES

For the aficionado:

The seats feature microfiber inserts to minimize wear over time and hold the occupants in position.

LEATHER DOOR PULL

EXPOSED CARBON FIBER

... inside is the d carbon fiber. ... which want intensity he mirror in carbon, ted in the captivating, time I've on a car's

– Motor Trend

Alfa Romeo 4C Immersion

Lightness and Efficiency

A True Top-Down Approach

- The core story of the 4C is about how lightness combines with efficient use of power to create a dynamic handling experience
- A very different approach from conventional use of brute force via maximum horsepower, torque, etc.
 - Uses some of the same materials/technology found on many F1 cars and supercars
 - Designed in collaboration with famed racing chassis designers Dallara Automobili

- Single carbon-fiber tub
- Aluminum and steel substructures
- Outstanding torsional stiffness
- Optimized center of gravity
- No power steering

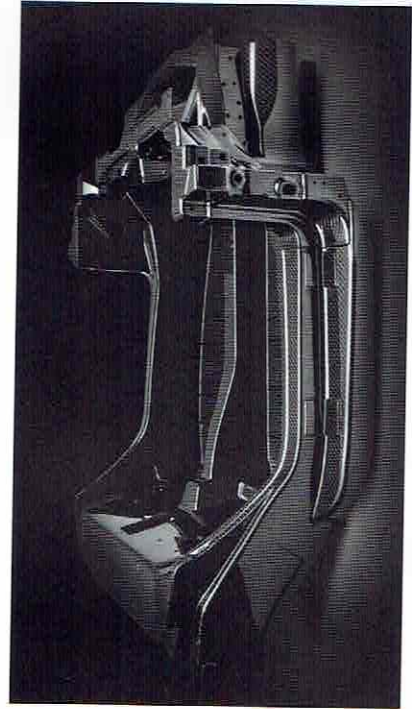

Praise for Passion

"The little Alfa is around \$200K cheaper than any other car with a carbon-fiber center and aluminum subframes. Aside from the McLaren, other cars constructed this way include the Lamborghini Aventador, Pagani Huayra, and Bugatti Veyron."

- Motor Trend

For the aficionado:

- Most Alfisti will know of, and have opinions on, famous coachbuilders such as Zagato, Bertone and Pininfarina
- They add a richness and diversity of design and style to Alfa Romeo vehicles

Alfa Romeo 4C Immersion

Lightness and Efficiency

LIGHTWEIGHT SMC BODY PANELS



Weight-Reduction Measures

- Sheet Molded Compound (SMC) body panels – 20% lighter than steel
- Lightweight glass – 10% thinner than traditional glass and 15% lighter
- Composite seat structures – rigid yet lighter weight than similar steel structures
- Manual HVAC controls – no need for unnecessary sensors/actuators
- Interior door pulls – lightweight leather straps supplant heavier molded door pulls

For the aficionado:

- SMC is a composite material that's typically compression molded and is made by a production process similar to fiberglass
- It's a high-strength glass-reinforced thermoset molding material that combines long glass fiber and polyester/phenolic/vinyl and acrylic modified resins
- While the resulting composite isn't as strong as carbon fiber, it's still incredibly strong and significantly lighter than steel

Alfa Romeo 4C Immersion

Lightness and Efficiency

A Solid Foundation

- Carbon-fiber monocoque chassis ("tub") – entire vehicle was designed around this centerpiece
 - Handcrafted carbon fiber laid in a unilateral direction – makes it 3X stronger and 7X lighter than conventional steel and offers unparalleled rigidity
 - Entire tub weighs a mere 143 lb (65 kg)
- Front and rear aluminum subframes – combine with the tub, roof reinforcements and engine mounting to comprise the 4C chassis
 - Total chassis weight – 236 lb (107 kg)
 - Total vehicle curb weight – just 2,465 lb (1,118 kg)

Experience 2

For the aficionado:

- Carbon fiber is basically strands of carbon, thinner than human hair, that are twisted together in a cloth-like mat
- It can be laid over a mold and then coated with a stiff resin or plastic in order to make it take on a permanent shape
- It's then cured in an autoclave – basically a large, pressurized oven
- "Pre-preg" carbon fiber is made from sheets that are "pre-impregnated" with resin but only partially cured for easy handling/molding

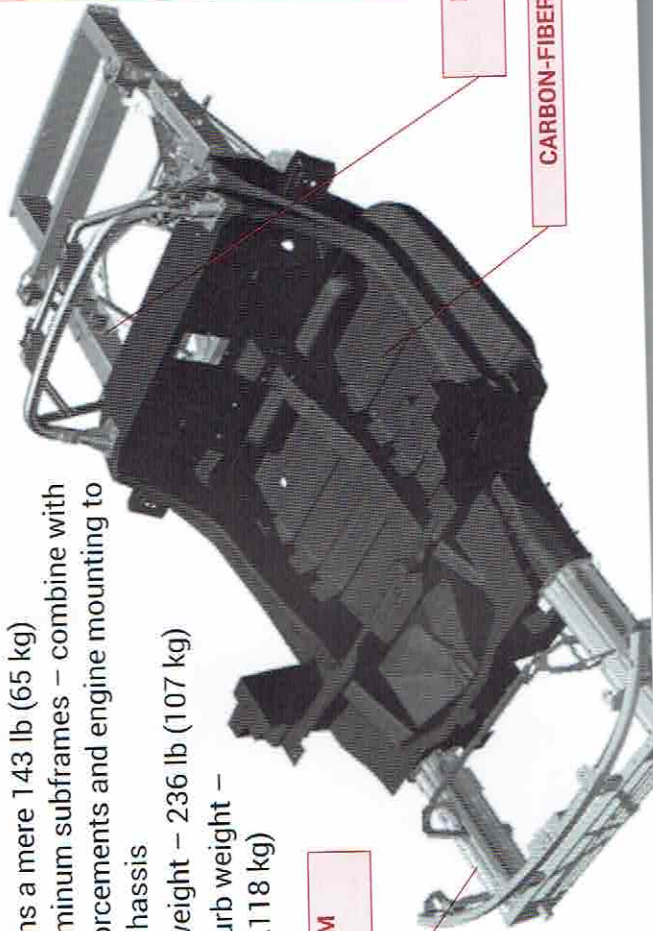

FRONT ALUMINUM SUBFRAME

REAR ALUMINUM SUBFRAME

CARBON-FIBER TUB

Alfa Romeo 4C Immersion

Lightness and Efficiency

Perfectly Balanced

- Mid-engine, rear-wheel-drive (RWD) layout – combined with the monocoque chassis, results in a near-ideal 41/59 front/rear weight distribution for superb handling characteristics and stability
- Double-wishbone front suspension with coil-over shocks – provides superior kinematic performance
- MacPherson strut rear suspension
- Front and rear sway bars

For the aficionado:

- A double-wishbone suspension uses a pair of wishbone-shaped arms to locate the wheel, each with two mounting points to the chassis. The shock absorbers and coil mount to the wishbone to control vertical movement; the geometry is highly "tunable" and is therefore preferred by engineers
- A MacPherson strut design is simple and compact yet provides numerous packaging advantages. Its minimalist, efficient design has been adopted by manufacturers from BMW to Porsche

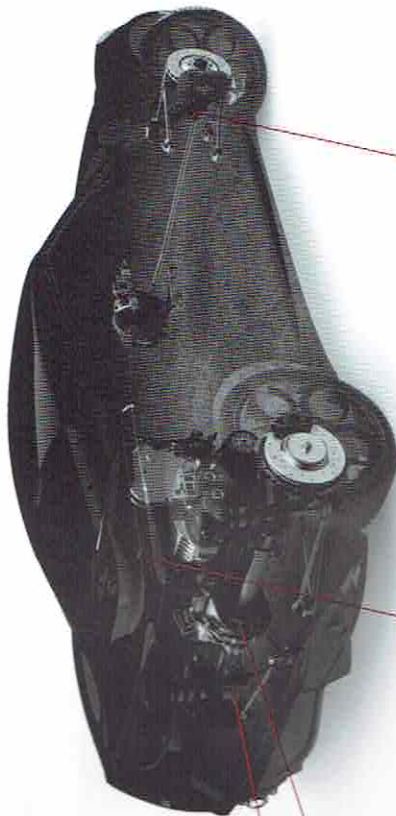

MACPHERSON STRUT REAR SUSPENSION

RWD

MID-MOUNTED ENGINE

DOUBLE-WISHBONE FRONT SUSPENSION



Alfa Romeo 4C Immersion Dynamism

Advantages of a Mid-Engine Layout

- Improved weight distribution – pays dividends with handling, balance and control
- More of the weight is placed over the rear-drive wheels – improves traction and reduces unwanted squat under hard acceleration and nose dive under hard braking
- Less parasitic power loss – no front-to-rear driveshaft, meaning torque gets more directly to the rear-drive wheels than a conventional front-engine, rear-wheel-drive layout

Praise for Passion

"Drive hard and smooth, and the 4C is one of the most neutral and natural cars you'll ever experience."

– Road & Track

Experience 2

SUPERIOR HEAT DISSIPATION

NO FRONT-TO-REAR DRIVESHAFT

MORE WEIGHT PLACED
OVER REAR WHEELS

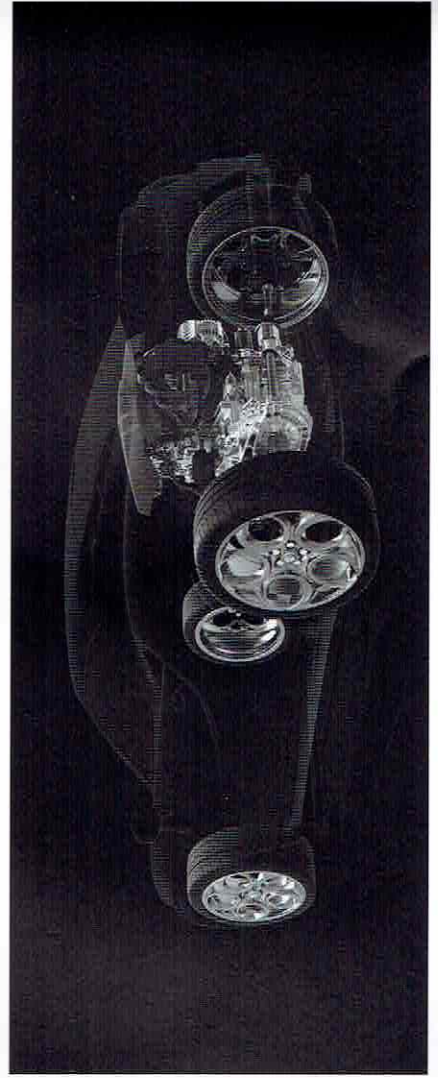

Alfa Romeo 4C Immersion Dynamism

A Potent Powerplant

- Transverse-mounted, 1.75-liter (1,750 cc) inline 4-cylinder
 - 237 hp @ 6,000 rpm
 - 258 lb-ft of torque @ 2,200 rpm
- Offers a stellar power-to-weight ratio
 - Considering the 4C's light 2,645-lb curb weight, each of the engine's 237 "horses" has a mere 10.4 lb to move
 - Allows the 4C to rocket from 0-60 mph in 4.5 seconds on its way to a 160-mph top speed

For the *aficionado*:

- Power-to-weight (PTW) ratio is a common yardstick for measuring the performance potential of a vehicle
 - Whereas "muscle cars" like Mustangs and Camaros achieve a positive PTW ratio by utilizing huge, high-output powerplants, the Alfa Romeo 4C achieves a highly competitive PTW ratio by maximizing lightness and making the most of its available power
- In addition, the 4C's approach offers highly nimble, responsive handling to complement the typical performance metrics
- As such, the 4C can accelerate as quickly as many muscle cars yet is able to corner sharper, brake harder, turn in more quickly and respond to driver inputs more readily than a muscle car can

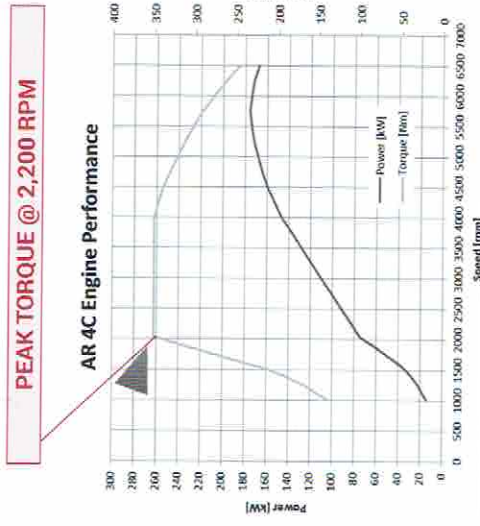



Alfa Romeo 4C Immersion

Dynamism

Engine Design

- Dual Overhead Cams (DOHC), 4 valves per cylinder, with roller-type hydraulic lifters
- Lightweight, all-aluminum design
- Dual-core intercooler – cools intake air before it reaches the turbocharger
- Direct fuel injection – sprays fuel directly into the cylinders to improve combustion, increase power and reduce emissions
- Electronic throttle control – links the accelerator pedal and throttle without a physical connection

DOHC

ALL-ALUMINUM DESIGN

DIRECT INJECTION

TURBOCHARGER

Experience 2

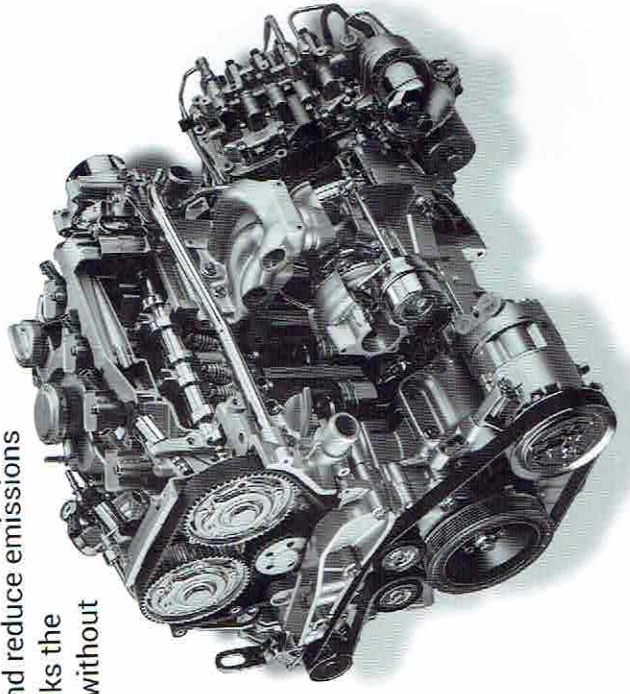

For the aficionado:

- Space is at a premium with the 4C, so rather than having one long intercooler, its dual-core intercooler allows more air to be cooled in a smaller area by stacking two smaller intercoolers on top of one another
- Electronic throttle control "connects" the accelerator to the throttle without a traditional mechanical linkage, delivering consistent throttle response regardless of conditions. It also improves gear changes and is one of the key enablers of the 4C's Launch Control

DUAL CVVT CONTROLLERS

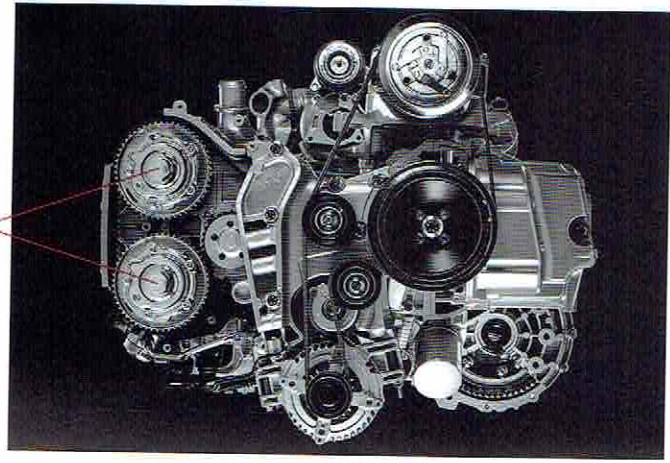

Alfa Romeo 4C Immersion

Dynamism

Engine Breathing

- Dual Continuous Variable Valve Timing (Dual CVVT) – optimizes intake and exhaust camshaft timing for improved engine responsiveness, improved fuel economy and reduced emissions
- Tuned exhaust – helps the engine “breathe” better and delivers a distinct exhaust note, particularly at high revs
- Scavenging technology – an innovative powertrain control module monitors and adjusts fuel dosage, CVVT positioning, injection timing and more

For the aficionado:

- Thanks to scavenging technology, the turbo's response times are more than halved, closely approaching those of a naturally aspirated engine
- Strong turbo response is available from 1,500-1,700 rpm, and torque at 2,500 rpm is 70% greater than that of a conventional turbo engine

...um with
...an having
...er, its dual-
...ows more
...a smaller
...wo smaller
...o of one
...control
...elerator to
...t a traditional
...e, delivering
...response
...itions. It also
...nges and is
...blers of the
...bl

Alfa Romeo 4C Immersion

Dynamism

6-speed Twin-Clutch Transmission (TCT)

- Two clutches – one takes care of the odd gear changes (1, 3 and 5) while the other handles the even ones (2, 4 and 6); this allows for rapid-fire shifting to help minimize shift lag and maximize track times
- Steering wheel-mounted paddle shifters – offer F1-inspired control and keeps the driver's hands on the steering wheel; right hand for upshifts, left hand for downshifts
- Electronic gear selector – simplifies the gear selection process

For the *aficionado*:

- On some premium vehicles, paddle shifters are mounted on the steering column, meaning they stay in place regardless of steering wheel position
- By contrast, the 4C's steering wheel-mounted paddle shifters move with the steering wheel, so the driver need not remove their hands from a firm grip of the wheel – this is a solution ideally tailored to a high-performance vehicle

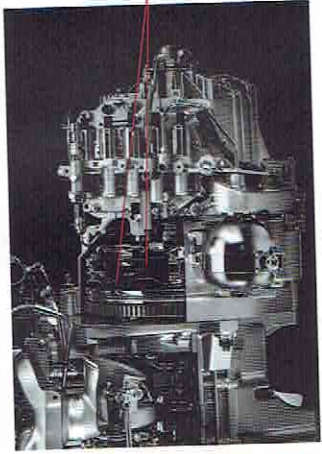

TWIN CLUTCHES

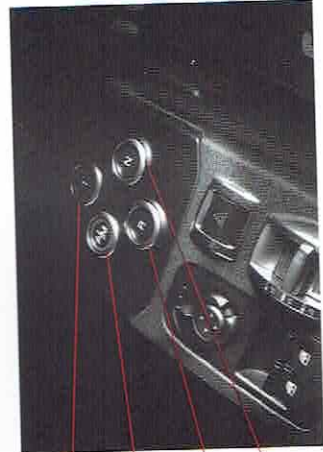

1 = 1ST GEAR/DRIVE

R = REVERSE

A/M = AUTOMATIC/MANUAL

N = NEUTRAL

Alfa Romeo 4C Immersion

Dynamism

D.N.A. Drive Mode Selector

- Optimizes powertrain and chassis calibrations according to driving performance and road conditions
- Adjusts shifting, ABS strategies, engine management, torque response and Electronic Stability Control (ESC) parameters
- Works in tandem with the Thin Film Transistor (TFT) cluster – varies the information shown based on the selected mode
- 4 modes:
 - D = Dynamic and Race
 - N = Natural
 - A = All-Weather

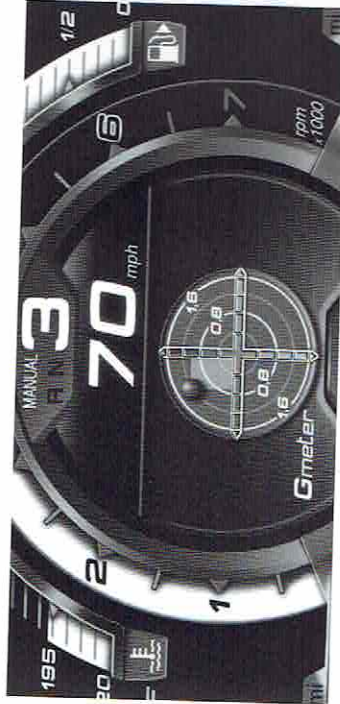

ALL-WEATHER

NATURAL

DYNAMIC AND RACE



NOTES

Alfa Romeo 4C Immersion

Dynamism

D.N.A. Drive Mode Selector. *Natural Mode*

- Default setting; returns to this mode after engine shutoff
- Normal ESC intervention threshold – only upon loss of grip
- Standard shifting speeds whether in automatic or manual
- Engine delivers maximum standard torque
- TFT shows:
 - Speed, current gear, rpm
 - Engine temperature, fuel level, odometer

For the aficionado:

- The D.N.A. toggle switch can be pressed forward or pulled back to change modes, but it always returns to the middle position
- Indicator lights on the side of the switch show which mode is currently active

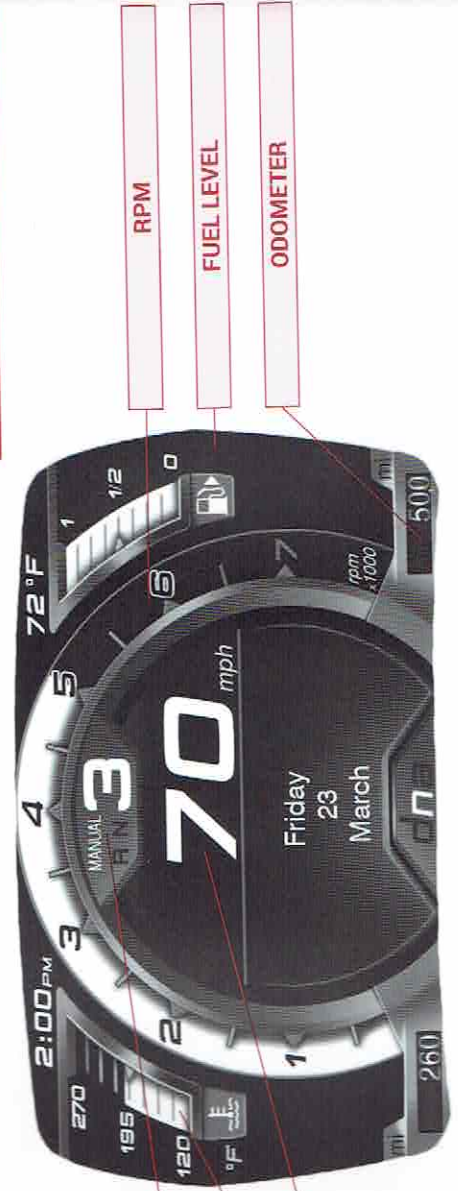

Alfa Romeo 4C Immersion Dynamism

D.N.A. Drive Mode Selector: *All-Weather Mode*

- Accessed by moving the D.N.A. Selector to "A"
- ESC intervenes more quickly – minimizes loss of grip on slippery surfaces
- Torque response is more gradual with same accelerator position
- Standard shifting speeds whether in automatic or manual
- TFT shows:
 - Blue background highlights to distinguish from Natural mode

For the aficionado:

- During new vehicle delivery, explain to your customers that if the 4C is turned off while in Natural, Dynamic or Race Mode, it will default to the Natural setting when restarted
- However, if the 4C is turned off while in All-Weather mode, it will remain in this setting even after being restarted
- This is by design, as it enhances safety

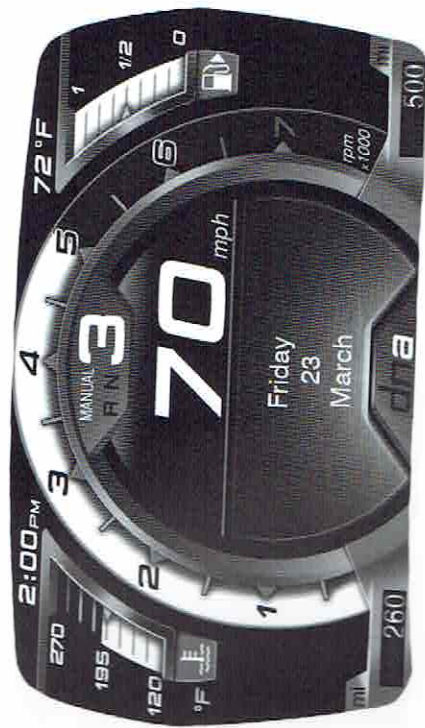

Alfa Romeo 4C Immersion

Dynamism

D.N.A. Drive Mode Selector. *Dynamic Mode*

- Accessed by moving the D.N.A. Selector to "D"
- More aggressive powertrain calibration and engine response
- Less intrusive ESC
- TCT delivers 25% quicker gear changes
- Minimized gear changing/response time whether in automatic or manual
- TFT shows:
 - Turbo boost gauge
 - Oil temperature gauge

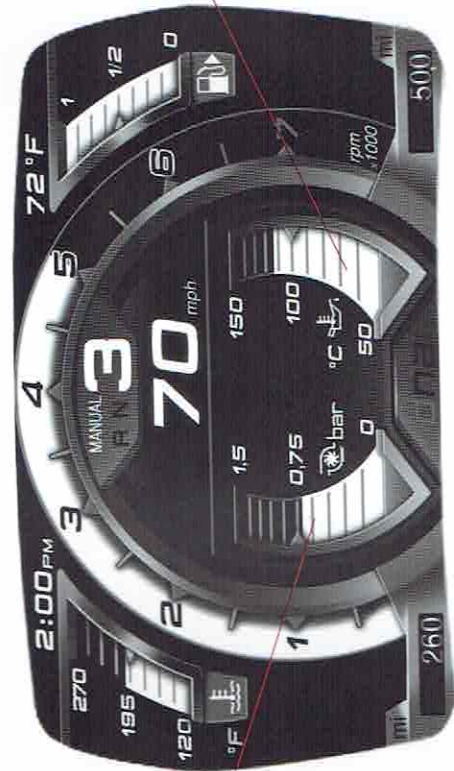

OIL TEMPERATURE GAUGE

TURBO BOOST GAUGE

Alfa Romeo 4C Immersion Dynamism

D.N.A. Drive Mode Selector. Race Mode

- Most extreme, unadulterated mode – this is where you'll find Launch Control
- ESC deactivated until brake activation thresholds are reached
- Electronic Q2 Differential Control System (EQDCS) remains active for fast corner exit
- Torque response is faster with same accelerator position
- Gear change timing is minimized (no automatic mode)
- TFT shows:
 - G meter – advanced telemetry with lateral/longitudinal acceleration gauge

For the aficionado:

- Race Mode is available only when the D.N.A. selector switch is already in Dynamic mode
- EQDCS uses the brakes to emulate a limited-slip differential
- In Race Mode, ESC may intervene when the brakes are engaged and certain thresholds are reached, but only by adjusting the brakes. ESC returns to its full off setting as soon as the brake pedal is released



GAUGE

ENGINE TEMP

G METER

RPM

4C PURE PASSION



Alfa Romeo 4C Immersion

Dynamism

Front Brakes And Tires

- 305 x 28 mm (12 x 1.1 in), cross-drilled, ventilated brakes
- Large size and optimized design contributes to excellent performance
- Four-piston Brembo® fixed calipers
- Two-piece rotor design with steel rotor and aluminum hat – aluminum offers lighter weight, less rotating mass, great heat dissipation, reduced pad wear and more consistent brake pedal feel
- Standard Pirelli P Zero™ 3-season tires – ideal for optimum weather conditions



For the aficionado:

- Cross-drilled rotors feature a series of drilled holes in the rotor to reduce weight and helps cool the brakes by improving airflow and dissipation of built-up gasses
- More effective cooling helps reduce brake fade and increases driver confidence
- Some sports cars feature floating brake calipers, where the calipers move in and out relative to the rotor. One or two pistons on the inboard side of the rotor push the entire caliper when the brakes are applied, creating friction from the brake pads on both sides of the rotor
- Fixed calipers don't move, and feature pistons arranged on opposing sides of the rotor. By applying braking pressure on both sides of the rotor, fixed calipers generally offer greater stopping power. Although a fixed-caliper design is more expensive, it's generally preferred for its superior braking performance

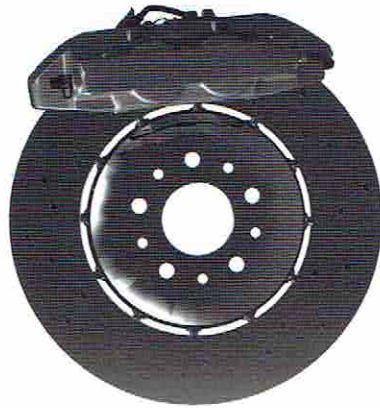

Praise for Passion

"It's impossibly wide, incredibly low and breathtakingly beautiful."

— Motor Trend

Alfa Romeo 4C Immersion Dynamism

Rear Brakes And Wheel Alignment

- 292 x 22 mm (11.5 x 0.87 in), cross-drilled, ventilated brakes
- Large size and optimized design contributes to excellent performance
- One-piece rotor design; one-piston, floating caliper
- 1.5-degree negative rear-wheel camber – wheels are angled inward slightly at the top

For the aficionado:

- Camber is the angle between the vertical axis of the wheels used for steering and the vertical axis of the vehicle when viewed from the front or rear
- If the top of the wheel is farther out than the bottom (away from the axle), that's positive camber
- If the bottom of the wheel is farther out than the top, that's negative camber
- Negative camber improves cornering attitude by placing the tire at a better angle relative to the road. This helps transmit the forces through the vertical plane of the tire rather than through a sheer force across it
- While camber enhances performance, it can also cause premature tire wear

ure a series
tor to reduce
he brakes by
dissipation of
helps reduce
as driver

re floating
he calipers
e to the rotor.
he inboard side
tire caliper
plied, creating
pads on both

ave, and feature
posing sides
g braking
of the rotor,
offer greater
gh a fixed-
expensive, it's
its superior

4C PURE PASSION

Alfa Romeo 4C Immersion

Dynamism

Unassisted Steering

- Provides an unfiltered connection to the driving experience
- Appropriate for a vehicle as performance-oriented as the 4C

Experience 2
Experience 4
Experience 6



Praise for Passion

"The Alfa's steering is purely mechanical. Said steering is also very quick, the combination providing an incredible level of feedback to the driver. We pundits keep lauding BMW on the sensitivity of its steering, but, by comparison, an M3 is a Mac truck with a blown hydraulic seal."

— David Booth, Postmedia News

Alfa Romeo 4C Immersion Advanced Technology

Hand-Assembled By Highly Skilled Technicians

- Handcrafted assembly – at Maserati's factory in Modena, Italy, expertly trained technicians oversee every phase of the process; their extensive inspections and quality control tests ensure impeccable assembly
- On-site engine break-in – every vehicle undergoes a thorough test-drive by a professional driver to certify that the engine and the car as a whole are in perfect working order

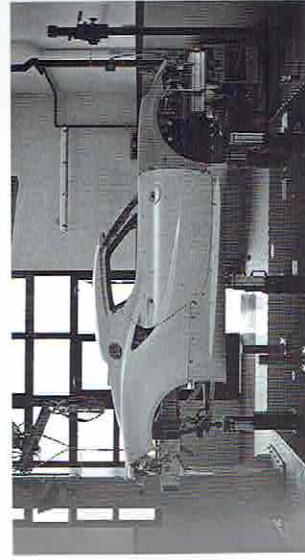
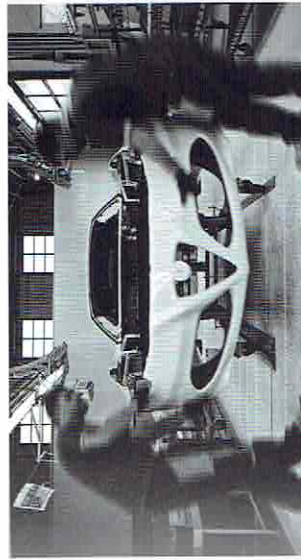

NOTES

...s purely
...ering is
...ombination
...le level of
...ar. We pundits
...n the sensitivity
...y comparison,
...k with a blown
Postmedia News

4C PURE PASSION

Alfa Romeo 4C Immersion Advanced Technology

Safety and Security

- Monocoque structure – serves as the safety cage; rigidity rivals that of modern race cars
- ESC, Antilock Brake System (ABS) and all-speed traction control – help keep the fun in check when the weather gets rough on the road or things get squirrely on the track
- Five air bags – driver and passenger front and side; driver-side knee blocker
- Remote keyless entry – includes central locking and engine immobilizer for added peace of mind
- Removable audio system faceplate – keeps would-be thieves at bay
- Ready Alert Braking
- Sentry Key Engine Immobilizer System
- Vehicle Security Alarm system

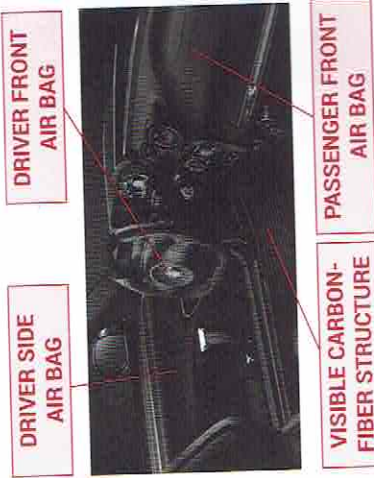

7-inch TFT Display

- Simple, crisp graphics – highly visible and legible, day or night
- Fully digital – eliminates the need for heavy cabling, gauges, glass covers, etc.
- Displays a wealth of information – time, ambient air temperature, fuel level, transmission mode and much more
- Highly adjustable – interacts with the D.N.A. Drive Mode Selector, changing the look of the display and the information presented accordingly

7-INCH TFT DISPLAY

FULLY DIGITAL READOUTS



Experience 2

Alfa Romeo 4C Immersion Advanced Technology

Comfort and Convenience

- 3G capable – effectively turns the 4C into a Wi-Fi hot spot
- Parrot Asteroid Classic audio system – features a 3.2-inch display, 4 speakers, AM/FM/CD player, MP3 compatibility, USB port, SD memory card and more - <http://www.parrot.com/usa/>
- Bluetooth® audio/voice recognition – driver can make hands-free calls, get directions and more
- Manual Heating, Ventilating & Air Conditioning (HVAC) – featuring simple, intuitive rotary knobs
- Power windows, mirrors and door locks – add push-of-a-button convenience

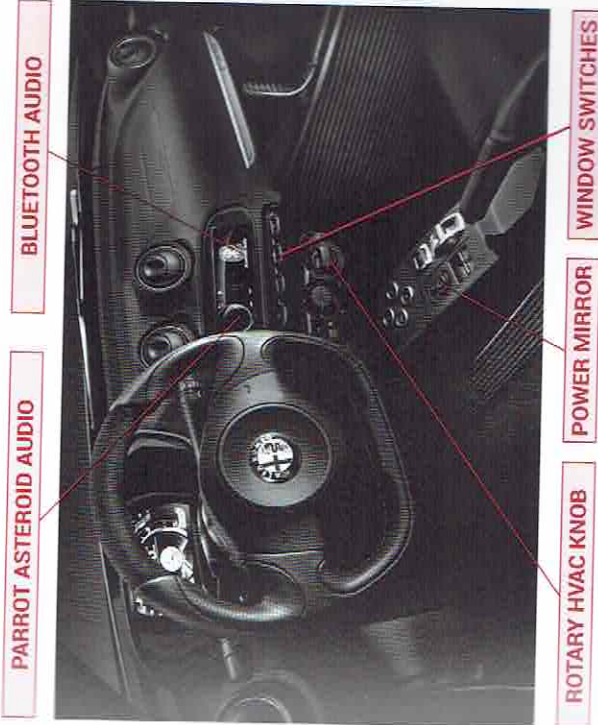

at of modern
help keep the
t squirrelly on
e blocker
oilizer for
y

FULLY DIGITAL HEADLIGHTS



Alfa Romeo 4C Immersion

Advanced Technology

4C Launch Edition

- Exclusivity factor – the first 500 units shipped to North America will feature a serialized Launch Edition plaque on the driveshaft tunnel
- Limited color palette – Rosso Alfa, Rosso Competizione or Madreperla White
- Comes standard with features that are otherwise optional on the 4C:
 - Carbon-fiber details – mirror caps, rear spoiler
 - Larger aluminum wheels – 18" front, 19" rear, forged Matte Black Diamond Finish wheels, Sport Exhaust System
 - Race suspension tuning – larger front/rear sway bars, performance-tuned shocks
 - Gloss Red painted brake calipers
 - And more

CF REAR SPOILER

MATTE BLACK DIAMOND FINISH WHEELS

MADREPERLA WHITE PAINT

GLOSS RED CALIPER

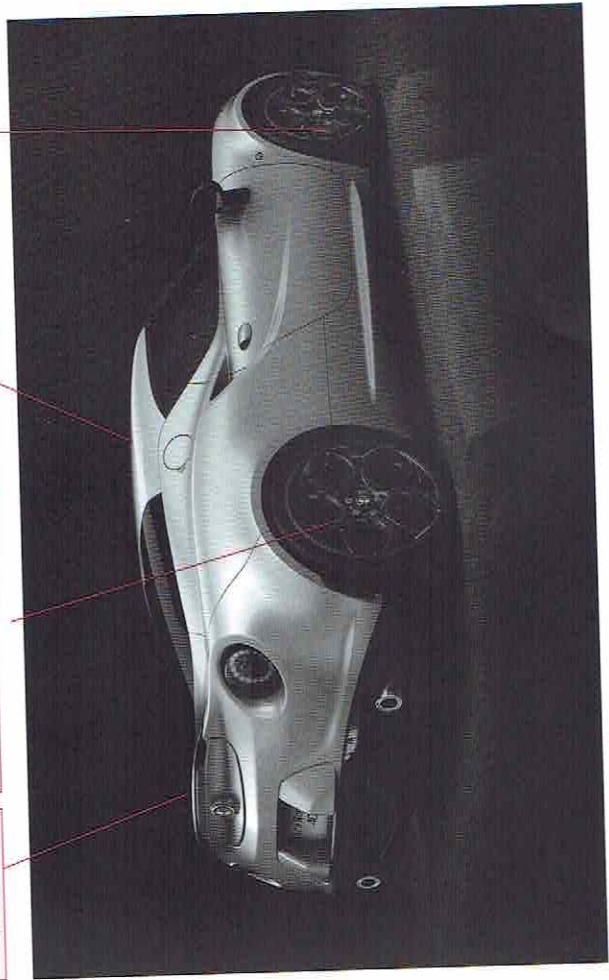

EXPERIENCE 2:

DRIVING PASSION

Alfa Romeo 4C Walkaround Features

2. DRIVER-SIDE

- Electronically adjustable, body-colored exterior mirrors
- Remote keyless entry with central locking and engine immobilizer
- Power locks and front windows with one-touch down
- Air conditioning

- 12-volt auxiliary power outlet
- Driver and passenger front and side air bags with driver knee blocker air bag
- Electronic Stability Control (ESC)** with all-speed traction control and Hill Start Assist

1. FRONT

- Sleek, sexy mid-engine coupe
- Unmistakable V-shaped grille and Alfa Romeo badge
- Aerodynamic with functional air intakes
- Racing technology carbon-fiber monocoque chassis with aluminum front and rear subframes
- Lightweight automotive glass
- Lightweight Sheet Molding Compound (SMC) body panels
- Available Bi-xenon headlamps with LED illuminated daytime running lights
- 17" X 7.0" front alloy wheels
- Four-piston Brembo fixed calipers with cross-drilled, ventilated rotors
- 205/45R17 front Pirelli P Zero 3-season tires

GLOSS RED CALIPER

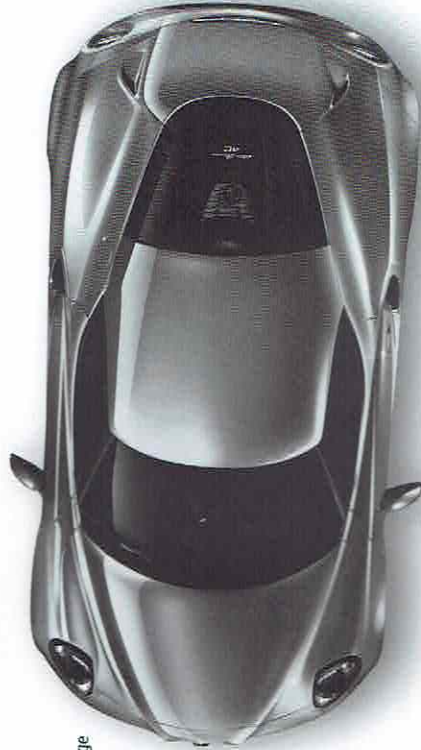

3. REAR

- Mid-engine, rear-wheel-drive design for ideal front-to-rear balance and superb performance handling traits
- 1750 cc I-4 direct-injected all-aluminum, transverse-mounted engine
- Turbocharger
- Dual-core intercooler
- 6-speed Twin-Clutch Transmission (TCT) with steering wheel paddle shifters
- Alfa Romeo D.N.A. Drive Mode Selector (Dynamic, Natural, All-Weather and Race Modes)
- Launch Control
- Aggressive negative rear-wheel camber
- LED taillamps

5. INTERIOR

- Driver-focused interior design and layout
- Exposed carbon-fiber structural sections
- Lightweight reinforced composite structure seats
- Microfiber-wrapped flat-bottom steering wheel
- Lightweight reinforced composite structure seats
- Console-mounted electronic gear selector
- 7-inch TFT color display cluster with high-impact graphics
- Tilt/telescoping steering column

4. PASSENGER-SIDE

- Capless fuel filler
- 18" X 8.0" rear alloy wheels
- 40R18 rear Pirelli P Zero 3-season tires
- Unassisted rack-and-pinion steering
- AM/FM stereo radio with Media Hub, Bluetooth® for hands-free calling and music streaming and four speakers
- Console with cup holder insert and optional rear lockable leather bag
- Optional body-colored rear spoiler
- Tire Service Kit

*The front air bags in this vehicle are certified to federal regulations for advanced air bags. Children 12 years old and younger should always ride buckled up in a rear seat. Infants in rear-facing child restraints should never ride in the front seat of a vehicle with a passenger front air bag. All occupants should always wear their lap and shoulder belts properly. **No system, no matter how sophisticated, can repeal the laws of physics or overcome careless driving actions. Performance is limited by available traction, which snow, ice and other conditions can affect. When the ESC warning lamp flashes, the driver needs to use less throttle and adapt speed and driving behavior to prevailing road conditions. Always drive carefully, consistent with conditions. Always wear your seat belt.

4C PURE PASSION

The Performance Market

A Unique Landscape

- Traditional comparison metrics don't really apply here
- Every vehicle in this segment is unique in its own right
- It's vital to acknowledge the competition's strengths while highlighting the 4C's merits and inherent strengths



Audi TTS



Porsche Cayman



Lotus Evora

BMW Z4

For the aficionado:

- We've included the vehicles that are most fundamentally similar to the 4C, but there's really not a direct Alfa Romeo competitor in this price range
- Any other vehicle offering a carbon-fiber chassis with aluminum subframes and a mid-engine layout is priced at or above \$200,000
- While the competitors we've included are in the general price and performance range of the 4C and are fine sports cars in their own right, none of them offers the pure performance design of the 4C

Experience 3

Alfa Romeo 4C vs. Porsche Cayman

Porsche Cayman Insights

- Mid-engine, 6-cylinder (boxer type), rear wheel-drive, 2-seat luxury sports coupe
- Well-established, credentialed sports car with strong industry reviews and enthusiastic fans
- Base MSRP \$55,800 (w/dual-clutch PDK transmission)
- Launched in 2006

NOTES



Alfa Romeo 4C vs. Porsche Cayman

Feature/Specification	Alfa Romeo 4C	Porsche Cayman
Length (in)	157	172.2
Wheelbase (in)	93.7	97.4
Curb Weight (lb)	2,465	2,888
Engine Size	1.75L 4-Cylinder	2.7L 6-Cylinder
Horsepower	237	275
Torque (lb-ft)	258	213
Pounds Per HP (lb/hp)	10.4	10.5
Transmission	6-Speed Twin-Clutch w/Paddle Shifters	7-Speed Double-Clutch w/Manual Mode
Drivetrain/Chassis Algorithm Modes	Yes	Yes
0-60 MPG (sec)	4.5	5.4

Alfa Romeo 4C vs. Porsche Cayman

Summary Advantages

- 4C is over 400 lb lighter – allowing it to get from 0-60 mph almost a full second faster than the Cayman
- The right wheelbase – 4C's shorter wheelbase makes for a more enthusiast-oriented experience and enhances visual appeal
- The right ratio – the 4C's 6-speed TCT has one less gear but keeps the engine in the powerband more of the time

4C offers:

- Stunning Italian style the Cayman can't match
- Alfa Romeo's signature dynamic combination of lightness, power and handling
- A hand-crafted carbon-fiber monocoque chassis
- A more purely performance-focused interior design philosophy



For the aficionado:

- Along with the BMW Z4 and Audi TTS, the Cayman is a vehicle intended for everyday use: around-town driving, commuting to/from work, etc.
- These vehicles feature a host of creature comforts, along with a reasonable amount of cargo space
- Conversely, the 4C – and, to some extent, the Lotus Evora – are not designed for grocery shopping, long weekend getaways, etc.
- This singular focus on ultimate driving excitement makes the 4C unique among its "competitive set"

4C PURE PASSION



Alfa Romeo 4C vs. Audi TTS

Audi TTS Insights

- Effectively a souped-up Audi TT
- Front-engine, turbo 4-cylinder, all-wheel-drive (Quattro®), 2-seat luxury coupe
- Well-optioned interior offers luxury accoutrements, infotainment and accessories
- Base MSRP \$48,700
- Launched in 2008



Alfa Romeo 4C vs. Audi TTS

Feature/Specification	Alfa Romeo 4C	Audi TTS
Length (in)	157	165.3
Wheelbase (in)	93.7	97.2
Curb Weight (lb)	2,465	3,263
Engine Size	1.75L 4-Cylinder	2.0L 4-Cylinder
Horsepower	237	265
Torque (lb-ft)	258	258
Pounds Per HP (lb/hp)	10.4	12.3
Transmission	6-Speed Twin-Clutch w/Paddle Shifters	6-Speed Dual-Clutch w/Paddle Shifters
Drivetrain/Chassis Algorithm Modes	Yes	Yes
0-60 MPG (sec)	4.5	5.3

NOTES

Experience 3
Experience 3

Alfa Romeo 4C vs. Audi TTS

Summary Advantages

- 4C is over 800 lb lighter – allowing it to get from 0-60 mph almost a full second faster (4.5 sec. vs. 5.3) despite the higher horsepower of the TTS
- 4C's rear-wheel-drive, mid-engine layout vs. Audi's famed Quattro all-wheel-drive system:
 - Rear-wheel-drive is widely accepted as the best combination for sports cars
 - Keeps weight down, reduces parasitic driveline losses and allows more power to be delivered to the road
- Mid-engine vs. front-engine layout – Audi has created a sportier version of the TT, but its engine remains up front
 - That can cause nose dive under braking
 - C's mid-engine design gives a more neutral dynamic feel

4C offers:

- Stunning Italian style the TTS can't match
- Alfa Romeo's signature dynamic combination of lightness, power and handling
- A hand-crafted carbon-fiber monocoque chassis
- A purer performance-focused design philosophy, inside and out



Audi TTS	
5.3	
2	
163	
4-Cylinder	
5	
8	
3	
Speed Dual- utch w/Paddle hifters	
es	
3	

4C PURE PASSION



Alfa Romeo 4C vs. BMW Z4

BMW Z4 Insights

- Front-engine, turbo 4- or 6-cylinder, rear-wheel-drive, two-seat sports convertible
- Largely seen as a grand tourer despite its sports-car intentions
- Offers a composed ride, top-notch interior materials and build quality
- Base MSRP \$48,950
- Current generation launched in 2009



Alfa Romeo 4C vs. BMW Z4

Feature/Specification	Alfa Romeo 4C	BMW Z4
Length (in)	157	167
Wheelbase (in)	93.7	98.3
Curb Weight (lb)	2,465	3,549
Engine Size	1.75L 4-Cylinder	3.0L-Cylinder
Horsepower	237	335
Torque (lb-ft)	258	332
Pounds Per HP (lb/hp)	10.4	10.6
Transmission	6-Speed Twin-Clutch w/Paddle Shifters	7-Speed Double-Clutch w/Manual Mode
Drivetrain/Chassis Algorithm Modes	Yes	Yes
0-60 MPG (sec)	4.5	4.8

NOTES

Experience 7

Experience 3

Alfa Romeo 4C vs. BMW Z4

Summary Advantages



BMW Z4	
167	
38.3	
3,549	
3.0L-Cylinder	
335	
332	
10.6	
7-Speed Double-Clutch w/Manual Mode	
Yes	
1.8	

- 4C is over 1,000 lbs. lighter – allowing it to get from 0-60 mph faster (4.5 sec. vs. 4.8) than the Z4 despite a power deficit
- Even with 335 hp, the Z4's power-to-weight ratio is 10.6 lb per hp to the 4C's 10.4
 - The Z4 needs a large, 3.0-liter, twin-turbo inline six-cylinder engine to compensate for its weight
 - Also, the Z4's front-engine design can diminish its sports-car handling traits
- 4C offers:
 - Stunning Italian style the TTS can't match
 - Alfa Romeo's signature dynamic combination of lightness, power and handling
 - A hand-crafted carbon-fiber monocoque chassis
 - A purer performance-focused design philosophy, inside and out





Alfa Romeo 4C vs. Lotus Evora

Lotus Evora Insights

- Mid-engine, naturally aspirated or supercharged 6-cylinder, rear-wheel-drive, two-seat sports coupe
- Low-volume vehicle using a lightweight, bonded-aluminum chassis and a modified Toyota V6 engine
- Base MSRP \$69,965 (Car and Driver)
- Launched in 2009



Alfa Romeo 4C vs. Lotus Evora

Feature/Specification	Alfa Romeo 4C	Lotus Evora
Length (in)	157	171
Wheelbase (in)	93.7	101
Curb Weight (lb)	2,465	3,048
Engine Size	1.75L 4-Cylinder	3.5L DOHC V6
Horsepower	237	276
Torque (lb-ft)	258	258
Pounds Per HP (lb/hp)	10.4	11
Transmission	6-Speed Twin-Clutch w/Paddle Shifters	6-Speed Manual w/Sports Ratios
Drivetrain/Chassis Algorithm Modes	Yes	No
0-60 MPG (sec)	4.5	4.8

For the aficionado:

- The name "Evora" keeps alive the Lotus tradition of beginning model names with an "E" (other examples include Elise, Exige and Esprit)
- "Evora" is a mashup of the words "evolution," "vogue" and "aura"

Alfa Romeo 4C vs. Lotus Evora Summary Advantages

- 4C is nearly 600 lb lighter – allowing it to get from 0-60 mph faster (4.5 sec. vs. 4.8) than the Evora despite a power deficit
- 4C D.N.A. Drive Mode Selector.
 - Evora doesn't offer any sort of electronic powertrain/chassis integration system
- Race-bred transmission – while the Evora offers both a 6-speed manual and a traditional 6-speed automatic, the 4C's TCT shifts much faster than either transmission
 - While the 4C's paddle-shifted TCT is a manual offering rapid-fire shifts, Evora's available paddle-shift automatic is a conventional gearbox
- 4C is, pound for pound, a better car – Evora's chassis is made of aluminum extrusions and features composite body panels, but the car is still 584 lb heavier than the 4C
 - The 4C's power-to-weight ratio is 10.4 lb. per hp to the Evora's 11.0
 - 4C's Formula 1-derived carbon-fiber monocoque chassis is incredibly lightweight

